



Laboratorní a zdravotnická technika OPTING servis
Bohumínská 788/61, 710 00 Ostrava 10, CZECH REPUBLIC
596241785; 596 241 960 fax 596 241 852 GSM 603 464 790
www.optingservis.cz E-mail: optingservis@optingservis.cz

Ophthalmic Instruments

HIGHEST OPTICAL QUALITY AND THE MOST ACCURATE DIAGNOSIS

HEINE ophthalmic instruments set the industry standard for optical quality and diagnostic accuracy. The HEINE range includes a wide variety of high quality ophthalmic instruments for all aspects of general and specialized examination of the eye: Direct and Indirect ophthalmoscopes, specialty ophthalmic instruments including retinoscopes, retinometers, hand-held slit lamps and ophthalmic examination lamps.

The innovative HEINE Ophthalmoscopes benefit from numerous patents and registered trade marks. The main features: The aspherical optical system (AOS) in HEINE BETA® Direct Ophthalmoscopes, the ParaStop® feature in the HEINE Retinoscope and the simultaneous adjustment of convergence and parallax in HEINE OMEGA® Indirect Ophthalmoscopes.





HEINE Direct Ophthalmoscopes



BETA200 S



BETA200



K180



mini3000



mini3000
LED

	BETA200 S	BETA200	K180	mini3000	mini3000 LED
Optical System					
Aspherical	<input type="checkbox"/>	<input type="checkbox"/>	<input type="checkbox"/>	<input type="checkbox"/>	<input type="checkbox"/>
Conventional	<input type="checkbox"/>	<input type="checkbox"/>	<input type="checkbox"/>	<input type="checkbox"/>	<input type="checkbox"/>
Illumination					
LED Illumination	<input type="checkbox"/>	<input type="checkbox"/>	<input type="checkbox"/>	<input type="checkbox"/>	<input type="checkbox"/>
XHL Illumination	<input type="checkbox"/>	<input type="checkbox"/>	<input type="checkbox"/>	<input type="checkbox"/>	<input type="checkbox"/>
Apertures					
	<input type="checkbox"/>	<input type="checkbox"/>	<input type="checkbox"/>	<input type="checkbox"/>	<input type="checkbox"/>
	<input type="checkbox"/>	<input type="checkbox"/>	<input type="checkbox"/>	<input type="checkbox"/>	<input type="checkbox"/>
	<input type="checkbox"/>	<input type="checkbox"/>	<input type="checkbox"/>	<input type="checkbox"/>	<input type="checkbox"/>
	<input type="checkbox"/>	<input type="checkbox"/>	<input type="checkbox"/>	<input type="checkbox"/>	<input type="checkbox"/>
	<input type="checkbox"/>	<input type="checkbox"/>	<input type="checkbox"/>	<input type="checkbox"/>	<input type="checkbox"/>
	<input type="checkbox"/>	<input type="checkbox"/>	<input type="checkbox"/>	<input type="checkbox"/>	<input type="checkbox"/>
	<input type="checkbox"/>	<input type="checkbox"/>	<input type="checkbox"/>	<input type="checkbox"/>	<input type="checkbox"/>
	<input type="checkbox"/>	<input type="checkbox"/>	<input type="checkbox"/>	<input type="checkbox"/>	<input type="checkbox"/>
	<input type="checkbox"/>	<input type="checkbox"/>	<input type="checkbox"/>	<input type="checkbox"/>	<input type="checkbox"/>
Corrective lenses					
Diopter Range	- 36 to +38	- 35 to +40	- 35 to +40	- 20 to +20	- 20 to +20
Number of Lenses	74	28	28	18	18
Single Diopter Steps	<input type="checkbox"/>	<input type="checkbox"/>	<input type="checkbox"/>	<input type="checkbox"/>	<input type="checkbox"/>
Dust protection					
Dustproof	<input type="checkbox"/>	<input type="checkbox"/>	<input type="checkbox"/>	<input type="checkbox"/>	<input type="checkbox"/>
Dust Resistant	<input type="checkbox"/>	<input type="checkbox"/>	<input type="checkbox"/>	<input type="checkbox"/>	<input type="checkbox"/>
Metal chassis	<input type="checkbox"/>	<input type="checkbox"/>	<input type="checkbox"/>	<input type="checkbox"/>	<input type="checkbox"/>
Instrument size					
Professional	<input type="checkbox"/>	<input type="checkbox"/>	<input type="checkbox"/>	<input type="checkbox"/>	<input type="checkbox"/>
Compact	<input type="checkbox"/>	<input type="checkbox"/>	<input type="checkbox"/>	<input type="checkbox"/>	<input type="checkbox"/>
Available Power Sources					
Battery 2.5V	<input type="checkbox"/>	<input type="checkbox"/>	<input type="checkbox"/>	<input type="checkbox"/>	<input type="checkbox"/>
Rechargeable battery 2.5V	<input type="checkbox"/>	<input type="checkbox"/>	<input type="checkbox"/>	<input type="checkbox"/>	<input type="checkbox"/>
Rechargeable battery 3.5V	<input type="checkbox"/>	<input type="checkbox"/>	<input type="checkbox"/>	<input type="checkbox"/>	<input type="checkbox"/>
Page	043	044	047	049	051

* Red free filter for all apertures except blue

HEINE BETA 200S® Ophthalmoscope

Superior aspherical optics and 74 single diopter steps



∴ Eliminates corneal reflex

∴ Ideal for small pupils

∴ 74 single diopter steps

∴ Dustproof

- ∴ **Unique optical system.** HEINE optimizes the Gullstrand principle with aspherical optics (separation of illumination and observation beam). Corneal and iris reflexes are eliminated. A full view is guaranteed even with small pupils.
- ∴ **XHL Xenon Halogen Technology.** Bright, white light.
- ∴ **Recessed, multi-coated viewing window.** Avoids stray light.
- ∴ **Dustproof housing.** Maintenance free.
- ∴ **Optics mounted on precision metal chassis.** Durable, precise.
- ∴ **Ergonomic shape.** Instrument fits the orbita comfortably in any position.
- ∴ **Soft orbital support.** Protects the user's glasses and steadies the instrument.
- ∴ **7 apertures with separate red-free filter.** Suitable for large or small pupils. Incorporates slit aperture, fixation star, cobalt blue filter and red-free filter for improved contrast.
- ∴ **Lens range:** Perfect focus even with high refractive errors.

74 single diopter steps

+ in 1 D steps: 1 through +38 D

- in 1 D steps: -1 through -36 D

BETA 200 S Ophthalmoscope	AV	TL
without handle	C-002.30.120	C-002.30.120 TL
XHL Xenon Halogen spare bulb	X-002.88.070	X-002.88.072

BETA200S apertures:



Cobalt blue filter, fixation star with polar coordinates, large spot, small spot, pinhole, slit, hemisplot



With red-free filter:

Cobalt blue filter, fixation star with polar coordinates, large spot, small spot, pinhole, slit, hemisplot

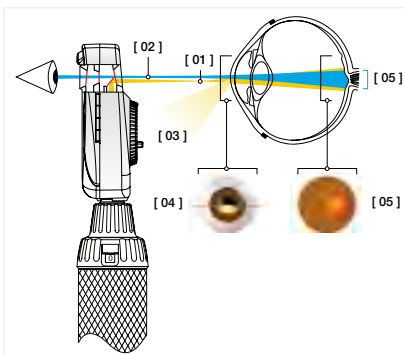

“Aspherical Optical System” (AOS) exclusively from HEINE

eliminates corneal and iris reflexes to provide large, crisp and glare-free fundus images.

- [01] Flat, elliptical illumination beam produced by HEINE's patented Aspherical Optical System.
- [02] Observation path.
- [03] Redirected iris and corneal reflexes.
- [04] The elliptical light beam enters through the lower half of the cornea. The illumination beam has been separated from the observation beam (Gullstrand-Principle). All reflexes are diverted away from the observation beam due to the curvature of the reflective cornea. Due to the flat, compressed form of the light beam, a maximum amount of light enters through the pupil.
- [05] Once past the anterior chamber, the light beam opens up dramatically to illuminate a large area of the retina.



HEINE BETA 200® Ophthalmoscope

The ophthalmoscope with superior aspherical optics



This ophthalmoscope offers all the features of the BETA 200S including the unique Aspherical Optical System. The exceptions are that there is no macula \ pinhole aperture and the following **range of lenses: 27 lenses from -35D to +40D.**

+ in 1 D steps:	1 – 10	15	20	40	D
- in 1 D steps:	1 – 10	15	20	25	35 D

BETA200 Ophthalmoscope	AV	TL
without handle	C-002.30.100	C-002.30.100 TL
XHL Xenon Halogen spare bulb	X-002.88.070	X-002.88.072

- ∴ Eliminates corneal reflex
- ∴ Ideal for small pupils
- ∴ Dustproof

BETA 200 apertures



Slit, fixation star with polar coordinates, cobalt blue filter, large spot, small spot, hemispot



With red-free filter

For more information on diagnostic combined sets, please see pages 159 -162.

HEINE BETA200®/200S® Ophthalmological Diagnostic Sets



Set complete with **BETA200S Ophthalmoscope**, hard case with:

BETA200S Ophthalmoscope Sets	3.5V (NiMH)	3.5V (Li ION)
BETA R rechargeable handle for mains socket	C-261.20.376	C-261.27.376
BETA NT rechargeable handle and NT 300 charger	C-261.20.420	
 BETA L rechargeable handle and NT 300 charger		C-261.29.420

 : Rechargeable handle with LED charge status display in the bottom insert.

 : To order your kit with the TL "Twist Lock" connection style, simply add the suffix "TL" to the end of the item number. e.g. B-141.20.376 TL for the set with Twist Lock.

HEINE BETA 200®/200 S® Ophthalmoscope Sets



Set complete with **BETA 200 Ophthalmoscope**, hard case with:

BETA 200 S Ophthalmoscope Sets	3.5V (NiMH)	3.5V
BETA R rechargeable handle for mains socket	C-144.20.376	C-144.27.376
BETA NT rechargeable handle and NT 300 charger	C-144.20.420	
BETA L rechargeable handle and NT 300 charger		C-144.29.420



Set complete with **BETA 200S Ophthalmoscope**, **BETA 200 Streak Retinoscope**, hard case with:

BETA 200 Diagnostic Sets	3.5V (NiMH)	3.5V
BETA R rechargeable handle for mains socket	C-262.20.376	C-262.27.376
BETA NT rechargeable handle and NT 300 charger	C-262.20.420	
BETA L rechargeable handle and NT 300 charger		C-262.29.420



Set complete with **BETA 200 Ophthalmoscope**, **BETA 200 Streak Retinoscope**, hard case with:

BETA 200 Diagnostic Sets	3.5V (NiMH)	3.5V
BETA R rechargeable handle for mains socket	C-145.20.376	C-145.27.376
BETA NT rechargeable handle and NT 300 charger	C-145.20.420	
BETA L rechargeable handle and NT 300 charger		C-145.29.420

: Rechargeable handle with LED charge status display in the bottom insert.

: To order your kit with the TL “Twist Lock” connection style, simply add the suffix “TL” to the end of the item number. e.g. B-141.20.376 TL for the set with Twist Lock.



HEINE Diagnostic Sets



Set complete: **BETA 200 Ophthalmoscope, BETA 200 F.O. Otoscope**,
1 set (4 ea.) of reusable tips (B-000.11.111)
5 of both AllSpec disposable tips 2.5 and 4 mm dia. (B-000.11.119)
hard case

Diagnostic Sets	3.5V (NiMH)	3.5V LI ION
BETA R rechargeable handle for mains socket	A-132.20.376	A-132.27.376
BETA NT rechargeable handle and NT 300 charger	A-132.20.420	
 BETA L rechargeable handle and NT 300 charger		A-132.29.420





Set complete: **BETA 200 Ophthalmoscope, BETA 100 Diagnostic Otoscope**,
1 set (4 ea.) of reusable specula (B-000.11.221)
10 UniSpec disposable tips 4 mm dia. (B-000.11.237)
hard case

Diagnostic Sets	3.5V (NiMH)	3.5V LI ION
BETA R rechargeable handle for mains socket	A-234.20.376	A-234.27.376
BETA NT rechargeable handle and NT 300 charger	A-234.20.420	
 BETA L rechargeable handle and NT 300 charger		A-234.29.420



Set complete: **BETA 200 Ophthalmoscope, BETA 200 Otoscope**

A-11 Diagnostic Set	3.5V (NiMH)	3.5V LI ION
BETA NT rechargeable handle and NT 300 charger	A-011.20.422	A-011.27.422
 BETA L rechargeable handle and NT 300 charger		A-011.29.420

: Rechargeable handle with LED charge status display in the bottom insert.

: To order your kit with the TL "Twist Lock" connection style, simply add the suffix "TL" to the end of the item number. e.g. B-141.20.376 TL for the set with Twist Lock.

HEINE K 180® Ophthalmoscope

Standard direct ophthalmoscope



∴ Reduces corneal reflex

∴ Dust resistant

A full featured instrument at an economical price.

- ∴ **Precision spherical HEINE optics.** Corneal and iris reflexes are reduced.
- ∴ **XHL Xenon Halogen Technology.** Bright, white light. Clear retinal image.
- ∴ **Ergonomical shape.** The instrument fits the orbita comfortably.
- ∴ **Soft orbital rest.** Steadies the instrument and protects your glasses.
- ∴ **Choice of 5 apertures.** For both large and small pupils.
- ∴ **Dust resistant housing.** Maintenance free.
- ∴ **High impact polycarbonate housing for durability.**
- ∴ **28 lenses from - 35 D to + 40 D.** Brilliant image even at high corrections.

+ in 1 D steps:	1 – 10	15	20	40	D
- in 1 D steps:	1 – 10	15	20	25	35 D

K 180 Ophthalmoscope	AV	TL
without handle	C-002.30.207	C-002.30.207TL
XHL Xenon Halogen spare bulb	X-002.88.086	X-002.88.085

K 180 apertures



Slit, red-free filter, cobalt blue filter, large spot, small spot

HEINE K 180® Ophthalmic Diagnostic Sets



Set complete: **K 180 Ophthalmoscope, K 180 F.O. Otoscope**

A-10 Diagnostic Set	3.5V (NiMH)	3.5V
BETA NT rechargeable handle and NT 300 charger	A-010.20.422	A-010.27.422
BETA L rechargeable handle and NT 300 charger		A-010.29.420

: Rechargeable handle with LED charge status display in the bottom insert.

: To order your kit with the TL "Twist Lock" connection style, simply add the suffix "TL" to the end of the item number. e.g. B-141.20.376 TL for the set with Twist Lock.





HEINE K 180® Diagnostic Sets

Set complete with: **K 180 Ophthalmoscope,**
K 180 Otoscope
1 set (4 ea.) of reusable tips (B-000.11.111)
hard case



K 180 Diagnostic Sets	2.5V	3.5V (NiMH)	3.5V LI ION
BETA R rechargeable handle for mains socket		A-279.20.376	A-279.27.376
BETA NT rechargeable handle and NT 300 charger		A-279.20.420	
 BETA L rechargeable handle and NT 300 charger			A-279.29.420

: Rechargeable handle with charge status display in the bottom insert.

: To order your kit with the TL "Twist Lock" connection style, simply add the suffix "TL" to the end of the item number. e.g. B-141.20.376 TL for the set with Twist Lock.

HEINE mini 3000® Ophthalmoscope

Compact Pocket Ophthalmoscope



Top quality ophthalmoscope with fixation star aperture in pocket format. Quality optics in mini format. Ideal for rounds and house calls. Can only be used with the mini 3000 handle system. Available in black or blue.

- ∴ **Enhanced XHL Xenon Halogen Technology.** Concentrated white light for perfect illumination and a brilliant image.
 - ∴ **2 piece handle and head.** Easy to maintain, flexible.
 - ∴ **Reduced Illumination filter** for light sensitive patients.
 - ∴ **5 different apertures.** A full-function instrument incl. fixation star (Reduced Illumination Filter).
 - ∴ **Range of lenses: - 20 D to + 20 D.**
- | | | | | | | | | | |
|---|---|---|---|---|---|---|----|----|------|
| + | 1 | 2 | 3 | 4 | 6 | 8 | 10 | 15 | 20 D |
| - | 1 | 2 | 3 | 4 | 6 | 8 | 10 | 15 | 20 D |
- ∴ **High quality handle: Chrome finish upper section/refined plastic.** Shockproof, sturdy, non-slip.
 - ∴ **Attachment clip with integrated on/off switch.** Secure. Switches off automatically when placed in the pocket. 20,000 switch cycles guaranteed.
 - ∴ **Replaceable batteries.** Size AA, or optional rechargeable battery with mini NT charger*.

- ∴ Modern pocket instrument
- ∴ Dust resistant
- ∴ Switches off automatically
- ∴ Optional rechargeable handle

mini 3000 Ophthalmoscope	2.5V
with mini 3000 Battery Handle, with batteries	D-001.71.120
without handle	D-001.71.105

XHL Xenon Halogen spare bulb	X-001.88.106
------------------------------	---------------------

mini 3000 apertures



Large spot, small spot, fixation star / reduced illumination filter, hemispot, red-free filter

HEINE mini 3000® Diagnostic Sets



Set complete with: **mini 3000 Ophthalmoscope** in hard case

mini 3000 Diagnostic Sets	2.5V
mini 3000 battery handle with batteries	D-852.10.021



*To upgrade to a rechargeable instrument, with mini NT charger, please see page 156.



HEINE mini 3000® Diagnostic Sets



All handles are fitted with batteries (AA size, or optional rechargeable battery with mini NT charger*). Please order spare bulbs separately.

Set complete with: **mini 3000 Ophthalmoscope**, **mini 3000 F.O. Otoscope**
 1 set = 4 reusable tips (B-000.11.111)
 5 of both 2.5 and 4 mm dia. AllSpec disposable tips (B-000.11.119)
 hard case

mini 3000 Diagnostic Sets	2.5V
with 2 mini 3000 battery handles with batteries	D-873.11.021
as D-873 but with mini 3000 Otoscope	D-873.21.021



*To upgrade to a rechargeable instrument, with mini NT charger, please see page 156.

HEINE mini 3000® pocket instruments – a complete range of quality diagnostic instruments for your pocket. Available in black or blue. Please specify the color you prefer when ordering. If not otherwise specified, we will supply black instruments.

HEINE mini3000® LED Ophthalmoscope

with LED Illumination in HEINE Quality HQ

NEW! LED HQ



Modern ophthalmoscope with maintenance free LED illumination. Its brightness and color rendering are comparable with a HEINE XHL Xenon Halogen Ophthalmoscope.

All of the features of the mini3000 Ophthalmoscope, with the addition of:

- ∴ **Maintenance free**, no need to ever replace the LED.
- ∴ LED Thermal management for a **consistent light output throughout the whole working life**.
- ∴ High-performance LED: bright and absolutely homogeneous **illumination with an excellent color rendering** – color temperature 4000K, color rendering index >95, and >90 rendering index of the color red.
- ∴ **Exclusive Battery Performance Indicator**: When the instrument is switched on, the maximum light intensity is shown, then the light intensity is regulated down to the level that corresponds to the current charge status of the battery so you know when your batteries need changing.
- ∴ **Exclusive fade-out function** reduces illumination intensity with battery level to let you know when to replace.
- ∴ **Operation time up to 10 hours**. The batteries need to be changed less often and the rechargeable batteries last longer.

- ∴ Maintenance free pocket instrument
- ∴ Optimal color rendering
- ∴ Up to 10 hours operation time

mini3000 LED Ophthalmoscope	2.5V
with mini3000 Battery Handle, with batteries	D-008.71.120
without handle	D-008.71.105

mini3000 apertures



Large spot, small spot, fixation star, hemispot, red-free filter

HEINE mini3000® LED Diagnostic Sets



All handles are fitted with batteries (AA size, or optional rechargeable battery with miniNT charger*).



Set complete with: **mini3000 LED Ophthalmoscope**
hard case

mini3000 LED Ophthalmoscope Set	2.5V
mini3000 battery handle with batteries	D-885.21.021



Set complete with: **mini3000 LED Ophthalmoscope, mini3000 LED F.O. Otoscope**
1 set = 4 reusable tips (B-000.11.111)
5 of both 2.5 and 4 mm dia. AllSpec disposable tips (B-000.11.119)
hard case

mini3000 LED Ophthalmoscope, mini3000 F.O. Otoscope Set	2.5V
with 2 mini3000 battery handles with batteries	D-886.11.021

LABORATORY AND MEDICAL EQUIPMENT

Laboratorní a zdravotnická technika OPTING servis
Bohumínská 788/61, 710 00 Ostrava 10, CZECH REPUBLIC
596241785; 596 241 960 fax 596 241 852 GSM 603 464 790
www.optingservis.cz E-mail: optingservis@optingservis.cz



*To upgrade to a rechargeable instrument, with miniNT charger, please see page 156.

HEINE mini3000® pocket instruments – a complete range of quality diagnostic instruments for your pocket. Available in black or blue. Please specify the color you prefer when ordering. If not otherwise specified, we will supply black instruments.